

Pressure Transmitters

Ex-protection II 2G Ex ib IIC T6 Gb according to ATEX

SIL 2 

PTMEx / PTMExFB
PTMExFG / PTMExFBFG

Applications

Pressure transmitters model PTMEx are suitable for liquid and gaseous media that do not corrode stainless steel. When connecting to a certified intrinsically safe circuit, the instruments have the type of protection II 2G Ex ib IIC T6 Gb according to ATEX.

Two basic models are available:

Overpressure Model PTMEx 0 – 1 bar to 0 – 400 bar
Model PTMExFB 0 – 1 bar to 0 – 60 bar
both versions also for vacuum and compound ranges (with ventilation to the atmosphere)

Absolute pressure (a) 0 – 1 bar to 0 – 25 bar
(reference point zero absolute)

The pressure transmitters are temperature-compensated and provide a calibrated output signal. The robust construction enables the application under difficult conditions, e.g. in shipping.

EMC-Examination

The pressure transmitters fulfil the stability requirements for the industrial sector, for residential and commercial areas according to the European standard and hence grant their electromagnetic compatibility.

Construction

The pressure transducer element is welded in the pressure connection piece. A thin stainless steel diaphragm separates the elementary sensor from the medium.

For pressure ranges from 0 – 250 bar onwards, a thin film sensor is directly welded to the pressure connection piece.

Standard Version

Construction Type

Installation length: standard

Process Connection

PTMEx : G 1/2 B (1/2" BSP), 1.4404 (316 stainless steel)
PTMExFB: pressure connection with membrane flush welded
G 1/2 B (1/2" BSP) according to DIN 3852

Measuring Cell / Sensor

Measuring cell: 1.4404 [316 stainless steel (piezo)]
1.4542 [630 stainless steel (thin film)]
Diaphragm (placed inside): 1.4404 [316 stainless steel (piezo)]
1.4542 [630 stainless steel (thin film)]

Sensor Sealing

– (measuring cell welded)

Case

Stainless steel, case protection type IP 65
Internal space ventilation for pressure ranges < 16 bar by plug screw fitting

Pressure Ranges / Overload

Pressure range-dependent, typically at least 2-fold,
details see pressure range table on back of the page

Output Signal

4...20 mA, 2-wire technique

Measuring Accuracy¹⁾

≤ ± 0.2 % of full scale value,
pressure ranges ≥ 60 bar ± 0.3% of full scale value

Temperature Ranges

Storage temperature: -40 ... + 90 °C (-40 ... +194 °F)
Rated temperature: -25 ... + 70 °C (-13 ... +158 °F)
Medium temperature: -10 ... + 80 °C (+14 ... +176 °F)
with temperature decoupler: -10 ... +140 °C (+14 ... +284 °F)

¹⁾ ± 0.3 % for pressure ranges > 60 bar



Temperature Influence in the Rated Temperature Range

Zero point: < 0.2 % / 10 K
Measuring span: < 0.2 % / 10 K

Reference Temperature

20 °C (68 °F)

Long-term Stability of Zero Point and Span

Better than ± 0.25 % p.a.

Reverse Voltage Protection

Available

Electrical Connection

Angular plug connector according to DIN EN 175301-803, 3-pin + protective contact; For assuring the electromagnetic compatibility (EMC), please use a shielded cable (e.g. LP/LiMYCY). The shield has to be connected to the case.

Electronics

Silicone-cast

Sensor Filling

Piezo: silicone-free synthetic oil
Thin film: without

Power Supply

6 ... 30 V DC, max. acceptable operating voltage 30 V DC

Influence of the Power Supply

≤ 0.1 % of full scale value / 10 V

Load Impedance

2-wire switching
 $R_{Bmax} = (U_B - 6 V) / 0.02 A$

Load Impedance Influence

For load impedance changing 500 Ω < 0.1 % of full scale value

Position of Installation

Any (standard vertical)

Ex-Approval

CENELEC-Approval ATEX
Explosion control intrinsically safe TÜV 04 ATEX 2432 X
 II 2G Ex ib IIC T6 Gb

$U_{max} < 30 V DC$ $I_{max} < 150 mA$
 $P_{max} < 1 W$ $C_i < 49 nF$
 $Li < 33 \mu H$



Sales and Export South, West, North
ARMATURENBAU GmbH
Manometerstraße 5 • D – 46487 Wesel-Ginderich
Tel.: +49 2803 9130 – 0 • Fax: +49 2803 1035
armaturenbau.com • mail@armaturenbau.com

Subsidiary Company, Sales and Export East
MANOTHERM Beierfeld GmbH
Am Gewerbepark 9 • D – 08344 Grünhain-Beierfeld
Tel.: +49 3774 58 – 0 • Fax: +49 3774 58 – 545
manotherm.com • mail@manotherm.com

9812
02/16

Pressure Ranges / Overloads, Special Versions, Accessory and Ordering Information

| Pressure Ranges / Overloads | | | |
|-----------------------------|---------------|-----------------------|-------------------|
| Overpressure (r) | | Absolute pressure (a) | Overload limits** |
| 0 – 1 bar | 1 / 0 bar | 0 – 1 bar abs | 3 bar |
| 0 – 1.6 bar | -1 / +0.6 bar | 0 – 1.6 bar abs | 10 bar |
| 0 – 2.5 bar | -1 / +1.5 bar | 0 – 2.5 bar abs | 20 bar |
| 0 – 4 bar | -1 / +3 bar | 0 – 4 bar abs | 60 bar |
| 0 – 6 bar | -1 / +5 bar | 0 – 6 bar abs | |
| 0 – 10 bar | -1 / +9 bar | 0 – 10 bar abs | |
| 0 – 16 bar | -1 / +15 bar | 0 – 16 bar abs | |
| 0 – 25 bar | | 0 – 25 bar abs | |
| 0 – 40 bar | | – | 100 bar |
| 0 – 60 bar* | | – | 250 bar |
| 0 – 100 bar* | | – | |
| 0 – 160 bar* | | – | 750 bar |
| 0 – 250 bar* | | – | |
| 0 – 400 bar* | | – | |

* accuracy $\pm 0.3\%$ of full scale value

** for intermediate pressure ranges upon request

Options

- Version with **temperature decoupler** for temperatures from $-10\text{ }^{\circ}\text{C}$ up to $+140\text{ }^{\circ}\text{C}$, order code letters **TE**
- Cable connection** IP 67, cable ventilation; **circular plug connector** with screw plug M 12, IP 65
- Field housing, order code: ...FG** (e.g. PTMExFG, PTMExFBFG), massive version, screwable cover ring with O-ring sealing for externally accessible adjustable potentiometer, screwable cap for connection chamber with O-ring thread protector, connecting terminals 4 mm^2 , screwed cable gland M 16x1.5 for cables $\varnothing 4.5 - 10\text{ mm}$.
- Other process connections:**
 - **Model PTMEx:** $\frac{1}{2}$ " NPT according to DIN EN 837-1 upon request
- Connection to Zone 0** using our screw adapter "Adapt-FS" (see top right); connection to Zone 0 by using an accordingly approved diaphragm seal upon request

Accessory

Flame arrester "**Adapt-FS**" ("flame penetration protection") Variant 1 according to data sheet 11001, made of 1.4571 (316 stainless steel) / cannula 1.4301 (304 stainless steel), process connection G $\frac{1}{2}$ B ($\frac{1}{2}$ " BSP) according to DIN EN 837-1, with CE-Type Examination Certificate PTB 99 ATEX 4023 X according to standard 94/9/EC, marking of this protection system:

Ex II G IIC

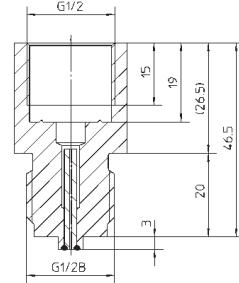

Ordering Information

| | | |
|---------------------------------|---|--|
| Basic model: | diaphragm placed inside diaphragm flush welded | PTMEx PTMExFB |
| Case configuration: | standard case field housing | no additional code letters FG |
| Medium temperature: | standard version (up to $80\text{ }^{\circ}\text{C}$) with temperature decoupler (up to $140\text{ }^{\circ}\text{C}$, see left side) | no additional code letters TE |
| Type of protection: | | ib |
| Marking with temperature class: | | T4, T5 or T6 |
| Pressure type: | overpressure absolute pressure | (r) (a) |
| Pressure range: | see table above, e.g. | 0 – 4 bar |
| Output signal: | standard optional | 4 ... 20 mA 0 ... 20 mA |
| Specifics: | e.g. process connection $\frac{1}{2}$ " NPT, M 22x1.5 and others, see left ; special position of installation, other special versions upon request | |

Examples:

PTMEx ib T6 (r) -1/+3 bar, 4...20 mA

(i.e.: PTMEx pressure transmitter with Ex-protection, standard version for max. medium temperature. $+80\text{ }^{\circ}\text{C}$, type of protection ib, temperature class T6, for overpressure -1/+3 bar, output signal 4 ... 20 mA, pressure connection G $\frac{1}{2}$ B)

PTMExFG TE ib T6 (a) 0 – 6 bar, 0...20 mA

(i.e.: PTMExFG pressure transmitter with field housing with Ex-protection, with temperature decoupler for max. medium temperature $+140\text{ }^{\circ}\text{C}$, type of protection ib, temperature class T6, for absolute pressure 0 – 6 bar, output signal 0 ... 20 mA (3-wire technique), pressure connection G $\frac{1}{2}$ B)

PTMExFB ib T5 (r) 0 – 40 bar, 4...20 mA, G 1 B

(i.e.: PTMExFB pressure transmitter with Ex-protection, standard version for max. medium temperature $+80\text{ }^{\circ}\text{C}$, type of protection ib, marking with temperature class T5, for overpressure 0 – 40 bar, output signal 4 ... 20 mA, (2-wire technique), pressure connection G 1 B)

Case Configurations, Dimensional Data and Weights, Connecting Diagrams

Standard Case

(no additional code letter)

Plug connector DIN EN 175301-803
ventilation via plug screw fitting
protection type IP 65

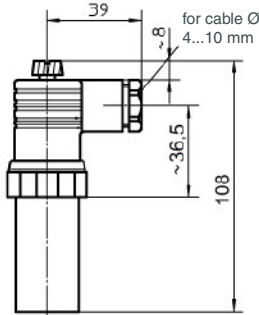

Cable connection
ventilation via cable
protection type IP 67

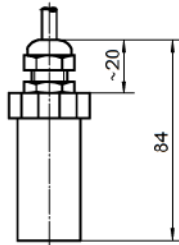

Circular plug connector
with screw plug,
ventilation via cable
protection type IP 65

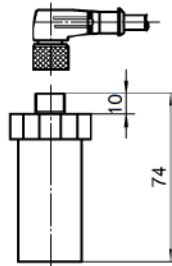

Weight for standard case:
with temperature decoupler + approx. 0.050 kg
approx. 0.200 kg

Field Housing

code letters **FG**

Screwed cable gland M 16x1.5
ventilation via sinter filter, IP 65
Option: ventilation via cable, IP 67

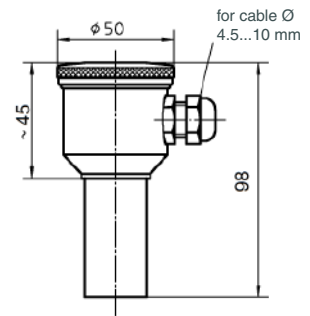

Weight
for field housing: approx. 0.460 kg
with temperature decoupler + approx. 0.050 kg

Options

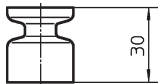

Temperature decoupler for process temperatures up to 140 °C

Process Connections

PTMEx (Piezo)

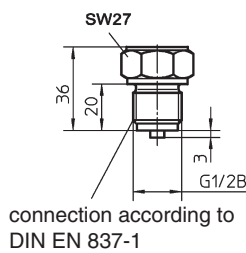

connection according to
DIN EN 837-1

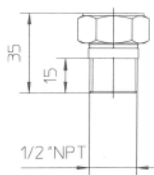

1/2" NPT

PTMEx (Thin film)

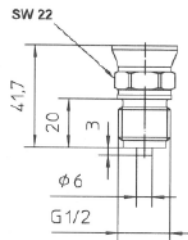

standard
G 1/2 B DIN EN 837-1

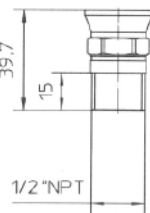

1/2" NPT

PTMExFB

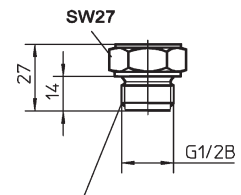

connection according to
DIN 3852 Form A

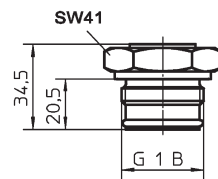

with O-ring NBR

Connecting Diagrams

Angular plug

2-wire
connection

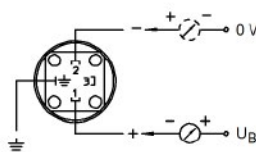

3-wire
connection

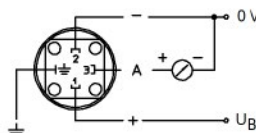

Cable connection

brown + UB
white earth
green 0 V/signal

Circular plug connector

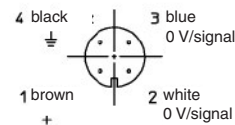

brown + UB
white earth
green 0 V
black 0 V/signal

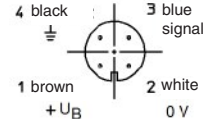

Field housing screwed cable gland M 16x1.5

